

ELECTRONIC ARTS®



EA
AIR FORCE

LHX

ATTACK
CHOPPER

ARTIST BIO

Chris Ebert (right) was born in Eugene, Oregon and hasn't sat still since. He discovered computers at age five in the wacky world of punch cards, but he didn't let it consume his life — not then



anyway. He was later abducted by space aliens and forced to get a degree from Santa Cruz in Biology and Music, and then get lost in the world of paper games. He got his start in commercial software writing music for computer games, and has now graduated to lead game programmer here at Electronic Arts.

Ian Clarke (left), at the age of nine, left his corner of the world — Coventry, England — and settled in a secluded region of the United States known as Seattle, Washington. His early years were filled with heavy learning as he tried his hand at many things, and found that he was right-handed. Armed with this information, he took to scooping ice-cream. This led to other tasks, and eventually he ended up with an Electrical Engineering degree, designing airplanes for The Boeing Company. Finally, he absconded to San Francisco, where he currently resides and works for Electronic Arts.

CONTENTS

STARTING THE GAME.....	1
CONTROLS.....	2
CALL TO ACTION	5
ENLIST AND EQUIP A NEW PILOT	6
Personnel Enlistment Form	6
Choose a Chopper and a Skill Level	7
PREPARE FOR YOUR MISSION	8
Mission Summary	8
Weather Report and Password Assignment.....	8
Mission Waypoint Map	10
In the Cockpit.....	10
Views and the Mission Waypoint Map.....	11
AFTER YOUR MISSION	12
Mission Outcome Report	12
Damage Report	13
Medals.....	14
YOUR FIRST MISSION	15
HELICOPTER TECHNICAL BRIEFINGS	23
LHX (Light Helicopter Experimental)	23
McDonnell Douglas AH-64A Apache	32
ALLIED HARDWARE TECHNICAL BRIEFING.....	43
ENEMY HARDWARE TECHNICAL BRIEFING.....	46



WARNING TO OWNERS OF PROJECTION TELEVISIONS

Still pictures or images may cause permanent picture-tube damage or mark the phosphor of the CRT (television screen). Avoid repeated or extended use of video games on large-screen projection televisions.

WANT PASSWORDS OR STRATEGY TIPS? CALL

1-900-288-HINT

1-900-288-4468

24 Hours a day, 7 days a week!

95c for the first minute, 75c for each additional minute. If you are under 18, be sure to get a parent's permission before calling. Hotline requires a Touch-Tone telephone and is only available in the US. Call length determined by user; average length is four minutes. Messages subject to change without notice.

NOTE TO HOTLINE CALLERS

To help you quickly locate the information you need, Electronic Arts will gladly send you printed hotline menus. To receive a copy, please send your name and address to

Hotline Menus

P.O. Box 7578

San Mateo, CA 94403-7578

Be sure to include the title and hardware format of the game you are playing.



STARTING THE GAME

1. Turn OFF the power switch on your Sega™ Genesis™. Never insert or remove a game cartridge when the power is on.
2. Make sure a Controller is plugged into the port labeled Control 1 on the Genesis Console.
3. Insert the game cartridge into the slot on the Genesis. To lock the cartridge in place, press firmly.
4. Turn ON the power switch. The title screen appears. (If you don't see it, begin again at Step 1.) After the title screen you see a demo of the LHX in action.
5. Press START to get into the action!

CONTROLS

Here are the controls available to you inside the cockpit of your helicopter.

CONTROLLER 1

Select Weapon	Button A
Fire Selected Weapon	Button B
Fire Chain Gun	Button C
View Map (Pause)	START (START again to return to cockpit)
Change View (On Map only)	D-Pad UP and DOWN
Change Waypoint	START + Button A (In Navigation Mode)
Drop/Pickup Supplies	START + Button B
Combat/Navigation Mode	START + Button C
Fly Forward	D-Pad UP
Fly Backward	D-Pad DOWN
Rotate Right	D-Pad RIGHT
Rotate Left	D-Pad LEFT
Bank Right	D-Pad UP + D-Pad RIGHT
Bank Left	D-Pad UP + D-Pad LEFT
Fly Up	START + D-Pad UP
Fly Down	START + D-Pad DOWN
Slide Right	START + D-Pad RIGHT
Slide Left	START + D-Pad LEFT

CONTROLLER 2

Move View Up	D-Pad UP
Move View Down	D-Pad DOWN
Next Target Right	D-Pad RIGHT
Next Target Left	D-Pad LEFT
Fire Weapon Two	Button A
Fire Weapon One	Button B
Fire Chain Gun	Button C
Time Compression	START

Here are the controls you will be using most often, to fly your chopper and fire its weapons.

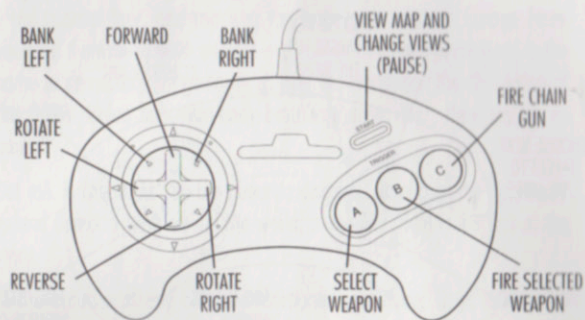

WHILE HOLDING DOWN START

Controls used less often are accessed by holding down START while pressing the buttons or D-Pad.

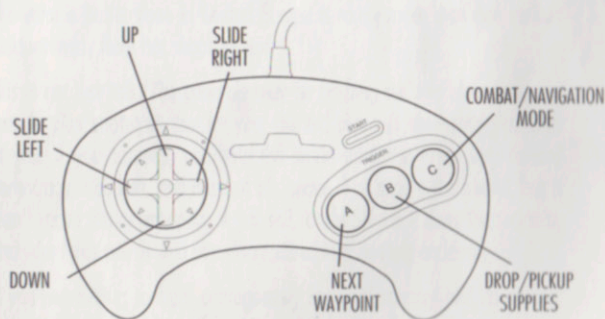

SECOND CONTROLLER

If you have a second controller, it can precisely control targeting and firing.

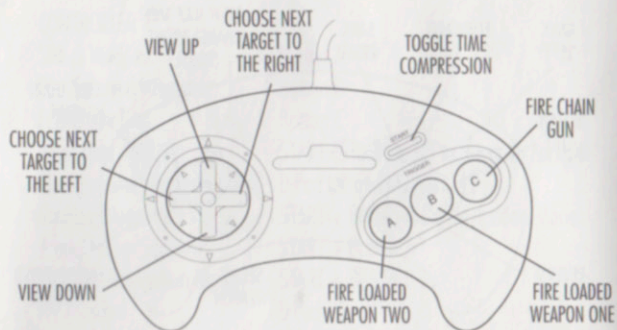

CALL TO ACTION

They say war is a thing of the past: the Berlin Wall is in pieces, China has lifted martial law, and most of the nations in eastern Europe have liberated themselves from ruthless and corrupt dictators. Revolutions in the name of democracy are going on all over the world, and the dissolution of the Soviet Union has everybody breathing easy. War, they say, is no more.

But talk is cheap. As you are about to discover, Americans are fighting to defend democracy all around the world, every day. Here is the rest of the story.

In the absence of any officially sanctioned retaliation, Libya relentlessly and with impunity supports attacks against US military installations and allied civilian populations.

Aggressive and brutal forces in Southeast Asia are trying to crush the lifeblood from struggling democracies as they valiantly struggle for the right to exercise freedoms we take for granted.

The volatile buffer zone in Central Europe is rarely more than one serious incident away from hot shooting war.

This is not just talk. The generals may be pushing red and blue pins on a map to plan strategies, but for you, the red pins will be shooting missiles at you. If you succeed, you help the world take one more step toward democracy, freedom, and most of all, peace. You may get a medal, but it won't make the newspapers. If you fail, Uncle Sam will deny the incident, and your folks will be told you disappeared in a boating accident.

If you are willing to fight courageously for your country and its values, take all the heroic risks and get none of the glory, follow the instructions below to enlist in the Air Cavalry of the US Army.

ENLIST AND EQUIP A NEW PILOT

These are the procedures you follow to enlist a pilot, assign him a chopper, prepare for your first mission, and get into the action.

PERSONNEL ENLISTMENT FORM

Press START from the title screen to enlist in the Air Cavalry and begin your Tour of Duty.

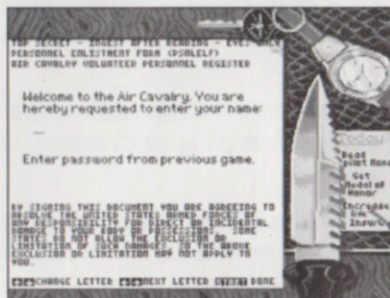

Personnel Enlistment Form

ENTER YOUR NAME

Use the D-Pad to enter your name, up to 20 letters.

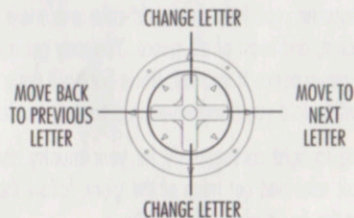

Press Start when you're done.

ENTER A PASSWORD IF YOU WANT

If you don't want to enter a password, just press START and move on to *Choose a Chopper*.

If you have played before and wrote down a password for a specific mission you want to attempt again, enter it now to return to that mission. Enter the password as you did your name, and press START to move on. The objectives demanded by the saved game may vary from what they were before.

If your last password appears and you don't want to use it, but you don't have a different one to use, just change one of the letters, press START, and you will continue as though you just started right out of flight school.

CHOOSE A CHOPPER AND A SKILL LEVEL

Use the D-Pad to choose to fly either the LHX or the Apache, and also to choose a skill level.

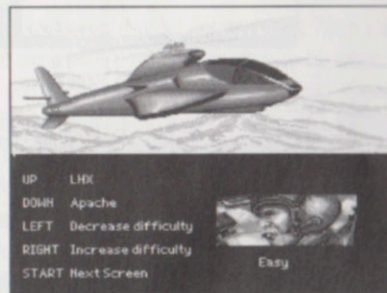
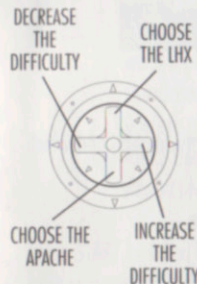

Press Start when you're done.

For information on the two helicopters, see *Helicopter Technical Briefings*. Once you choose a helicopter for your pilot, they are bonded for life. To fly another helicopter in other missions, you must enter another pilot.

PREPARE FOR YOUR MISSION

These are the procedures of receiving your mission orders and preparing to fly to your objective.

MISSION SUMMARY

Read the mission summary to get important information about your designated targets.

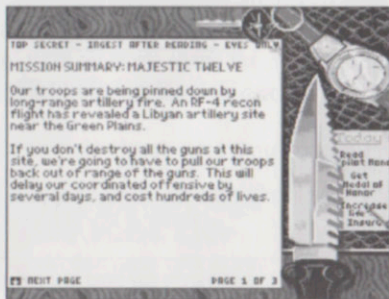

Mission Summary

Pay special attention to reading which are the primary targets, and which will earn you extra credit with the Powers that Be.

Press **START** or **D-Pad Down** to move to the next page.

WEATHER REPORT AND PASSWORD ASSIGNMENT

Read the Weather Report to learn the current weather conditions, and to write down the password for the mission.

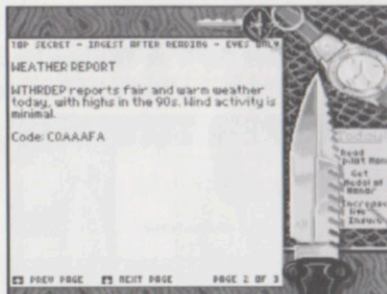

Weather Report and Password Assignment

Take special note of wind, which can push your chopper into the ground if you fly too low.

Write down the password to return to this mission at this point at a later date.

NOTES: The password saves your rank but not your score. When you enter a pilot name and a password, you return to the mission associated with that password, at the rank you were at, and you are given the minimum number of points possible for that rank. See the Table of Promotions in the *Mission Outcome Report* section that follows.

Press **START** or **D-Pad Down** to move to the next page. Or **D-Pad Up** to go back to the previous page.

MISSION WAYPOINT MAP

Examine the Mission Waypoint Map to see the relative locations of your Takeoff Point, the Mission Objective, and the Landing Destination.

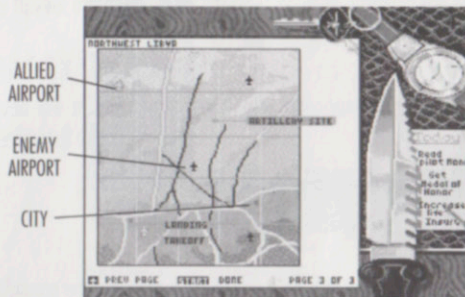

Mission Waypoint Map

Unless you're feeling extra ambitious, enemy airfields are good places to avoid on route to and from your mission objective.

Press START to go to your chopper on the airstrip. Or D-Pad Up to go back to the previous page.

IN THE COCKPIT

All missions begin in the cockpit of your chopper.

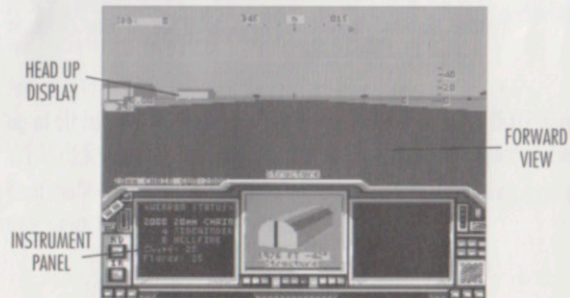

LHX Cockpit

Fly your mission to the best of your ability, and return yourself and your bird to your destination airstrip intact. For a Tutorial that guides you through your first mission, see *Your First Mission*.

VIEWS AND THE MISSION WAYPOINT MAP

Press and release START to call up your Mission Waypoint Map in your cockpit.

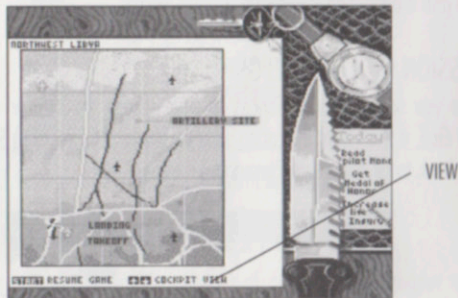

Mission Waypoint Map and Views

D-Pad Up or D-Pad Down to change the view, and press START to return to your mission with the selected view engaged. There are ten views other than the normal cockpit view to choose from.

While reviewing your Map, the game is paused.

AFTER YOUR MISSION

When you land at your destination airport, the mission ends and you are returned to the ready room for your debriefing. Even if you can't make it back to your destination airport, try for any allied airfield, or land on the ground in friendly territory at the very least. If you are lucky enough to be rescued, you are brought immediately to your debriefing where you are handed your Mission Outcome Report. If you aren't rescued, you become MIA and a debriefing is the least of your worries.

MISSION OUTCOME REPORT

Here you see the consequences of your actions, positive or negative. If you died, a short note indicating so is presented, and pressing START takes you back to fill out a new Personnel Enlistment Form.

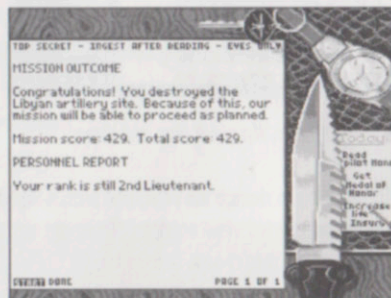

Mission Outcome Report

You are given your score for the mission, and your total score for that pilot to date. You receive points for succeeding in your mission and for destroying enemy targets. You lose points for accidentally destroying allied forces and for not going to your assigned destination. The harder the mission, the more points it's worth, and using the Apache gives you more points than the LHX for the same mission performance.

With enough points, you gain promotions, which are listed below in your Personnel Report.

Table of Promotions

Mission Points	Rank
0	Second Lieutenant
2,000	First Lieutenant
6,000	Captain
10,000	Major
16,000	Lieutenant Colonel
25,000	Colonel

Press START to move on to get your aircraft Damage Report.

DAMAGE REPORT

The Damage Report details the amount of damage your chopper took, including the time estimated to repair it, and the total cost to the American taxpayers.

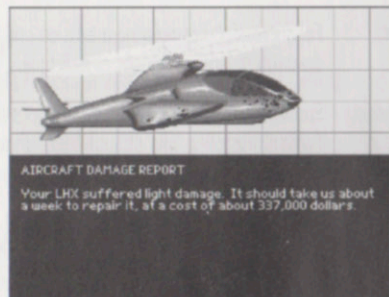

Damage Report

Press START to move on.

MEDALS

If you perform above and beyond the call of duty, you might get a medal, and this medal will be shown alone. (When you finish all the missions successfully, you are shown all the medals you have earned.) The minimum skill level you need to have chosen is listed after the description of each medal. If you aren't going to be awarded any medals, you go straight to your next mission briefing.

Medals	Criteria
Purple Heart	For sustaining an injury in combat. <i>Very Easy.</i>
Silver Star	For successfully completing a moderately difficult mission and performing above and beyond the mission goals (2,000 points). <i>Medium.</i>
Distinguished Flying Cross	For successfully completing a moderately difficult mission and for downing at least six fixed-wing aircraft. <i>Medium.</i>
Air Medal	For successfully completing a mission and for downing at least six planes or helicopters. <i>Easy.</i>
Good Conduct	For successfully completing four missions in a row (without restoring your status with a password). <i>Very Easy.</i>
Arms Forces Expeditionary Medal	For successfully completing missions in all three theaters (without restoring your status with a password): Libya, Southeast Asia, and Central Europe. <i>Very Easy.</i>

Press **START** to go straight to your next mission briefing.

YOUR FIRST MISSION

This section is an overview of the different procedures involved in flying and fighting, and you should be flying a helicopter as you read it. For a list of the controls referred to in this section, see *Controls* at the beginning of this manual. For more information on the instruments mentioned in this section, see *Helicopter Technical Briefings*. For more information on other vehicles, see the other *Hardware Technical Briefings*.

Note: For this Tutorial, start with a new pilot and choose the LHX as your helicopter.

TAKE OFF

Taking off in a helicopter is as simple as flying straight up. To do so, hold down **START** and **D-Pad up** to gain altitude (watch your altimeter to the right of your HUD, or on the instrument panel of the Apache).

At a respectable altitude, say 125 feet, release **START** and the **D-Pad** and the helicopter will hover. You will hear the landing gear retract shortly after takeoff.

GET COMFORTABLE WITH THE FLIGHT CONTROLS

The **D-Pad** represents a combination of many helicopter controls: the collective, the cyclic, the rudders, and the engine power output. Spend some time experimenting with all the flight controls listed in the *Controls* section at the start of this manual, until you are comfortable with them all.

FLY TOWARD THE MISSION OBJECTIVE

When you start a mission, the *Mission Objective* is logged in your flight computers as your next destination, or *Waypoint*. There is a small arrow on the compass at the top of your forward view, indicating the direction to fly to head towards your destination. When the arrow is off the screen

because it is off the scale of the compass, a large red arrow appears on the right or left of the compass to tell you which direction to turn to face your destination.

If you want to highlight a different waypoint so you can use the HUD arrow to navigate, press Start+A until the waypoint you want is highlighted.

Once facing the right direction, fly in that direction at top speed by pressing D-Pad UP. On the way to your target, get to know your helicopter in the following ways.

ARM DIFFERENT WEAPONS

When you start a mission, the armed weapon is the chain gun — look to the bottom left of your Head Up Display (HUD) to see the name of the armed weapon. Pressing the fire button (B) will fire that weapon. Press Button A to cycle through the weapons you have — watch how the name changes. Stop when the weapon reads HELLFIRE: 8.

SEE HOW TARGETING WORKS

As targets appear in your forward view, the targeting computer chooses the closest one and puts a square over it. A camera view of the target appears on your instrument panel, and it lists important information about the target.

If you have a second controller, you can override the target selection and select your own. See the *Controls* section for details.

CHECK OUT THE RADAR WARNING RECEIVER

The instrument to the lower right is the Radar Warning Receiver, which shows you all the targets surrounding you, both allied and enemy. Your RWR does not distinguish between allied and enemy targets; remember that you may be flying over civilian airspace, so check your targets

carefully. Primarily use the RWR to avoid flying into an area hotter than a single helicopter can handle.

REVIEW THE WAYPOINTS FOR YOUR MISSION

Press START and Button C together to disengage the Combat Computer and change your displays to Navigation Mode.

The center display now shows your waypoints in the order you are to fly to them. This always starts with Takeoff, always ends with the Landing Destination, and in between are your Mission Objectives, either one or two locations.

Beneath each waypoint name is its relative distance and *bearing*. The bearing is the waypoint's direction relative to the direction you are facing. The direction is shown in degrees on a circle, with positive degrees to the right, negative degrees to the left. For example: bearing 0 is straight ahead, 90 is 90 degrees to your right, -90 is 90 degrees to your left, and both 175 and -175 are almost directly behind you.

Notice how one of the waypoints is highlighted. The highlighted waypoint is the one programmed into the flight computer as your next waypoint, and the arrows on your compass are pointing toward that waypoint. When you get close to a waypoint, the computer switches to the next one, even if you haven't finished your work at the current one, so only use the directional arrows during travel, not during combat.

You can move the highlight to different waypoints by pressing START and Button A together.

USE THE RIGHT WEAPON

Weapons are not interchangeable. You can use weapons for roles other than they are intended, in an emergency, but they are always much less effective than the right weapon.

Sidewinders and Stingers

These missiles are most effective against aircraft and ineffective against armor or structures. They are infrared-seeking fire-and-forget weapons. As soon as one is fired, it homes in on the heat source of its target and requires no assistance from you. This makes it possible for you to quickly fire multiple air-to-air missiles at different targets.

Hellfires

Hellfires are laser guided air-to-ground missiles specifically designed to pierce armor, but they can occasionally be effective against slow-moving helicopters. A laser designator on your helicopter illuminates the target, and the missile homes in on the reflection. This means that you must hold your target lock on the target until the missile reaches the target. If you target something else while the Hellfire is in flight, the missile will turn and home in on the new target. This makes it impossible to quickly fire multiple Hellfires at different targets because they will all go to the currently illuminated target. Also, if the target moves out of your field of vision, out of range, or makes you lose your target lock for any reason, the Hellfires lose their laser guidance.

Guns and Rockets

Guns are fired in bursts of more than one round, with one tracer to show the ammunition's flight path. Although guns do not give you a target lock, because they aren't guided weapons, they are fired toward the tracked target if it is on the ground. *The guns will not fire at the tracked target if the target is an aircraft.*

57mm FFAR rockets always fire straight ahead from the helicopter and do not track the current target. You must orient your helicopter to face the target directly, lining up the HUD center crosshair on the target, before firing. The best weapon to fire on structures are the 57mm FFAR rockets, and they have a proximity fuse that makes them effective even when not carefully aimed.

The chain gun in the Apache fires armor-piercing rounds, and it is effective against all targets. The guns on the LHX are less effective against armor and structures.

If you happen to acquire TOW missiles, be advised that you can steer them with the D-Pad in the Missile View mode.

DESTROYING TARGETS

When the target is surrounded by a square only, it is being tracked only. You must get close enough to get a target lock, which is indicated by a diamond over the rectangle. Look to your hit percentage to see what the chances are of hitting the target. The number of targets often exceeds the number of missiles you have, so don't waste shots on anything less than 100% hits unless you have to.

Keep in mind that the percentage to hit you see is for the armed weapon. That number isn't valid for any of your other weapons. If you press Button C to fire your chain gun at a target that reads 100%, but you're not hitting it, it could be that a missile is highlighted — missiles have a greater range than the chain gun.

COMPLETE THE MISSION OBJECTIVE AND GET OUT

Make sure you have completed your mission as described in your preflight briefing. On the way home, take out whatever targets you have weapons for, but don't take foolish chances. It cost too much money to train you and build your bird.

ENEMY AVOIDANCE AND COUNTERMEASURES

Recognizing how vulnerable your helicopter is to enemy fire is the first step in understanding the importance of not engaging the enemy head-to-head. The first, best defense against enemy attack is avoiding detection. This is best done by flying NOE (Nap of Earth; i.e. hugging the ground) and staying as far as you can from enemies on your Radar Warning Receiver (RWR). Take the time to fly around potential hotspots on the way to your mission waypoint.

Avoiding initial detection is important for two reasons. Most immediate, you avoid taking hits from nearby enemy vehicles. Secondly, when the enemy knows your position, they vector aircraft into the area to intercept you.

Guns are unguided, but if the enemy is using radar to aim their guns, they fire ahead of you, or *lead* you with their guns. Fly zigzags to confound this technique. If the enemy is not using radar, they are firing *directly* at you. Fly across their field of view to avoid getting hit.

If you do get pulled into combat, your Countermeasures Panel is your best friend. This panel consists of two lights, the Radar (RD) Light, and the Infrared (IR) Light. If the light comes on yellow, then you have been fired upon with a missile — the missile is tracking you on radar or infrared, depending on which lights comes on. Soon after the light turns yellow, the electronic countermeasures engage automatically, signified by the light turning from yellow to red. If after a few seconds the jammers are successful in breaking the missile's tracking, the light goes out. If they are unsuccessful, the light returns to yellow and you had better try some evasive maneuvers. Flares and chaff cartridges are dispensed automatically when missiles get close.

LANDING

Landing is as simple as hovering and then lowering yourself down. When you reach the destination airport at the end of a mission (or if you need to touch down elsewhere for emergency reasons) first hover over the center of the runway. Gently lower yourself by pressing and releasing START and D-Pad Down together. Be careful not to move any direction but down, because trying to land while moving laterally can make you crash.

In the event you lose your engines, you must make a controlled landing without power to your blades. Autorotation is a technique that keeps the rotors turning freely until the last moment, near the ground, when helicopter speed is traded for rotor speed, slowing the helicopter in time to touch down safely.

Here is how to Autorotate: when the rotor disengages, drop the nose of your aircraft to increase forward speed as you fall out of the sky. The more forward speed you can get the better, because your high speed keeps the main rotor spinning. Then in the last hundred feet, press START and D-Pad Up together, pressing and releasing to gently touch down.

SOME TACTICS

When flying into a hot LZ (landing zone), take out the enemy radar vehicles first. Many of the surrounding vehicles depend on them for target search/tracking support. When you arrive at your mission waypoint, you must target enemies to activate the camera view. If the target your weapon is locked on to is the mission goal, the message [MISSION GOAL] appears in the camera. Complete your mission. Don't forget, you might have multiple targets at each mission waypoint. And be sure to save some ammo for the trip home.

PICKING UP/DROPPING OFF

Some missions require you to pick up or drop off men or supplies, or you can pick up crates of munitions in the occasional abandoned crates. If your mission is to pick up men, hover directly above the man (you might find it helpful to select an exterior view — See the *Views* section for details) and reduce altitude to less than twenty feet. The man will climb on board. If your mission is to drop off supplies, hover close to the ground and, when you are over the target waypoint, press START and Button B simultaneously to activate the winch. If you drop it out of the target area, land next to it and press START and Button B to pick it up again. Hover over the correct location more carefully this time, nose into the wind, and drop it again.

HELICOPTER TECHNICAL BRIEFINGS

LHX (LIGHT HELICOPTER EXPERIMENTAL)

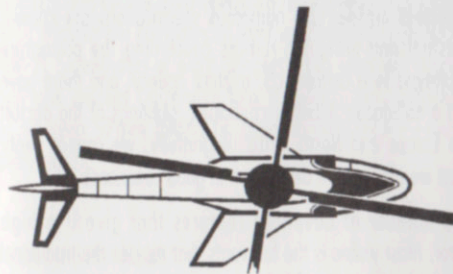
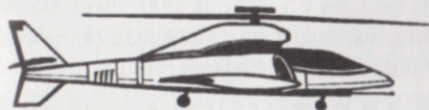

Scout/Attack (SCAT) Helicopter

Crew	1
Main rotor diameter	11.5 m
Tail Rotor diameter	None — Ducted fan technology
Length incl. rotor	15.23 m
Height	3.77 m
Weight (take off)	3,550 kg
Max level speed	330 km/hr (206 mph) @ sea level
Range	1,425 km
Ceiling (Hover-OGE)	2,745 m (9,000 ft)

There was no doubt that the aerodynamic and structural efficiency of helicopters, as well as their general performance, could be improved with advanced composite structures in rotor blades and the fuselage, and also with computerized FBW (fly-by-wire) or FBL (fly-by-light) flight controls. With this fact in mind, the U.S. Army, in 1982, asked interested manufacturers to submit designs for its proposed Light Helicopter Experimental (LHX) family of combat helicopters.

While no LHX has been seen by the public (except as drawing-board mockups), its general outlines and numerous specifications are known. There are persistent and intriguing rumors concerning the premature release of a prototype to a certain U.S. military agency, and there have been more than a half-dozen, albeit unconfirmed, sightings of the aircraft in both eastern Europe and North Africa. Regrettably, we cannot verify these rumors; but we also cannot deny them in good conscience.

The LHX has a number of advanced features that give it a high survivability factor. Most visible is the tail vents that replace the traditional helicopter tail rotor. In conventional helicopters, the tail rotor is extremely susceptible to damage, even from small arms fire. In the LHX, a ducted fan pumps air out through vents in the tail to counteract the torque generated by the main rotor. This approach is not only less vulnerable to weapon fire, but it is much quieter, making the LHX more difficult to locate.

Avionics

The LHX is required to fly all-weather, day and night, NOE (nap-of-the-earth) missions. To achieve this it uses ADOCS (advanced digital/optical control system) technology, a triply-redundant electronic flight control system, which has replaced hundreds of conventional helicopter mechanical control links. This makes the LHX much simpler, more reliable, and more survivable on the battlefield. The nose of the LHX is an unglazed

stealth nose, covered in low observables RAM (radar absorbent material). Adding this to advanced IR suppression techniques makes the LHX more difficult to spot than any helicopter ever built.

Armaments

According to Army specifications, the LHX accommodates a single-barrel 20mm automatic cannon (maximum ammunition load of 2,000 rounds) positioned in the forward fuselage and ordnance stores carried in the fuselage and on the fixed wings. To reduce the LHX's radar signature, air-to-air missiles are carried in an internal hardpoint, capable of carrying four AIM-9L Sidewinders or eight Stingers. Each wing will support four Hellfire anti-tank missiles (maximum total of eight), four TOW anti-tank missiles, or nineteen 57mm folding fin aerial rockets (FFAR—maximum total of thirty-eight).

FLIGHT INSTRUMENTS

Here is a complete description of the LHX cockpit.



LHX Cockpit

Countermeasures Panel

This panel tells you when enemy weapons fire upon you plus the status of your countermeasures.

This panel consists of two lights, the Radar (RD) Light, and the Infrared (IR) Light. If the light comes on yellow, then you have been fired upon with a missile — the missile is tracking you on radar or infrared, depending on which lights comes on. Soon after the light turns yellow, the electronic countermeasures engage automatically, signified by the light turning from yellow to red. If after a few seconds the jammers are successful in breaking the missile's tracking, the light goes out. If they are unsuccessful, the light returns to yellow and you had better try some evasive maneuvers. Flares and chaff cartridges are dispensed automatically when missiles get close.



Head Up Display

Superimposed on your forward view is your Head Up Display (HUD), which allows you to see various important flight data without looking down into your cockpit.

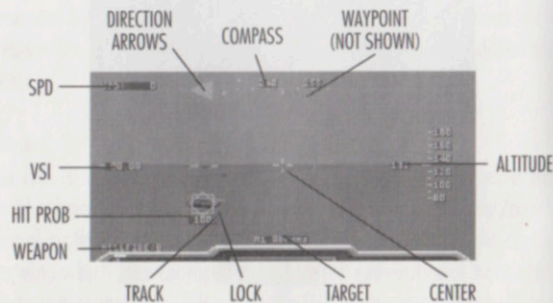

LHX Head Up Display

HUD symbology in the LHX is as follows:

- SPD** Forward air speed in miles per hour. This number is positive when flying forward, negative when flying backwards.
- VSI** Vertical speed in thousands of feet per minute. This number is positive when ascending, negative when descending.
- ALTITUDE** On the left is your altitude in feet; on the right is the scale.
- COMPASS** Your heading in degrees, with N, E, S, and W indicating the four compass points.
- WAYPOINT** Align this arrow with the center tick mark to fly toward your highlighted waypoint.
- DIRECTION ARROWS** This red arrow appears on the right or left to tell you which direction to turn to face your waypoint.
- CENTER** The centerline of your helicopter, which is your gunsight.
- WEAPON** Your selected weapon and number remaining.
- HIT PROB** Probability that selected weapon will hit current target.
- TARGET** Target identification.
- TRACK** This square is superimposed over the target you're currently tracking with your selected missile.
- LOCK** This target-lock diamond is superimposed on the tracked target when it comes within range of your selected guided missile.

Multi-Function Displays



The Multi-Function Displays (MFD) are video monitors, also called CRTs (Cathode Ray Tubes), with two modes, Navigation mode and Combat mode. You can switch between them by pressing START and Button C together.



Camera: A video image along with range, bearing, and status information of the target you're currently tracking. If your current target is your mission goal, the display [MISSION GOAL] appears on the camera view.

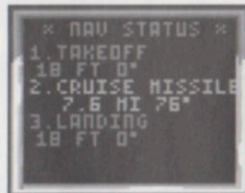

Nav Status: Your list of mission waypoints, along with range and bearing information for each waypoint.

If your HUD is damaged, look at this display to see information about where to turn to fly toward waypoints.



Radar Warning Receiver (RWR): Your Radar Warning Receiver displays potential threats in your area — your helicopter is always the dot in the center.

Your RWR does not distinguish between allied and enemy targets. Remember that you may be flying over civilian airspace, so check your targets carefully.

Note: Some targets in the area do not have a sufficiently strong signature to be detected by your RWR, so do not trust it 100 percent. An enemy infantry armed with automatic weapons or portable SAMs (Surface-to-Air Missiles) never appear on your RWR.



Weapon Status: This panel displays the number of weapons remaining on your aircraft and the currently selected weapon.

The top weapon is your internal chain gun. The numbers next to the hardpoints represent the total amount of weapons for that hardpoint on both sides of the fuselage. Your onboard weapons computer automatically fires from both sides of your helicopter in turn to keep the weight

distribution roughly equal. If a hardpoint is damaged in combat and becomes unusable, the name of that hardpoint's weapon reads "**DAMAGED**".

Press Button A to cycle through your weapons. The highlighted weapon is selected, and it discharges when you press Button B.

If your HUD is damaged, look at this display to see which weapon is armed.

Also included on the bottom of the display are the chaff and flare counts.

Chaff Count The number of chaff cartridges you have — these are fired automatically when you are attacked by a radar-guided missile.

Flare Count The number of flares you have — these are fired automatically when you are attacked by a heat-seeking missile.

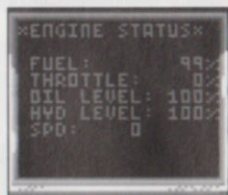

Engine Status (ENGINE): The Engine Status Panel displays fuel level, throttle settings, and fluid pressures in your helicopter.

The systems are as follows (all but the speed are displayed as percentages of maximum):

FUEL: Fuel Amount
THROTTLE: Throttle Setting
OIL LEVEL: Engine Oil System
HYD LEVEL: Hydraulic Control System
SPD: Ground speed in miles per hour

If your HUD is damaged, look at this display to see ground speed data.

Running out of fuel makes your engines cut out immediately. Loss of oil pressure eventually burns out your engine. When you lose engine power for any reason, you must autorotate to land safely. (When you run out of fuel, the symbol AR appears as the throttle setting.) See the "Landing" section in *Your First Mission* for a description of this procedure.

Loss of hydraulic pressure leads cripples your helicopter. Both your thrust and flight controls become ineffective. When you lose control of your helicopter, you have little choice but to attempt to land.

MCDONNELL DOUGLAS AH-64A APACHE

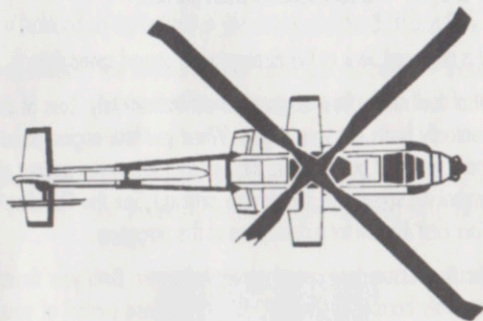
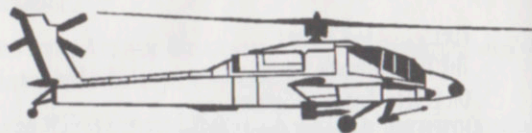

Anti-Armor Attack Helicopter

Crew	2
Main rotor diameter	14
Tail Rotor diameter	2.7
Length excl. rotor	14.7 m
Height excl. rotors	5.5 m
Weight (take off)	6,500 kg
Max level speed	365 km/hr (228 mph) @ sea level
Range	689 km
Ceiling (Hover-OGE)	2,440 m (8,000 ft)

As an engine performance specification, the Army demanded that the helicopter achieve a vertical climb rate of 450 fpm (feet per minute) in 95 degree heat at 4,000 feet. Apache achieves 1,450 fpm (1,000 fpm more than the Army required), the unequalled maneuverability envelope which ranges from +3.5g to -0.5g makes the Apache capable of performing very rapid changes in flight path when flying close to the ground or in air-to-air combat without overloading the structure.

In general the helicopter is a conventional design, with an all metal semi-monocoque fuselage and stainless-steel/fiberglass rotor blades. Where it parts company with and outstrips its predecessors of similar design is in its survivability. With its IR-suppressed engines, comprehensive EW (electronic warfare) installations, and most importantly an airframe and systems designed to live through medium-sized projectile strikes, the aircraft exemplifies capability and survivability.

The Apache's airframe has a high ballistic tolerance. It is designed to be completely invulnerable to 12.7mm armor-piercing incendiary rounds. Individual components will survive a hit by a single 23mm high explosive incendiary projectile. The aircraft's survivability ratio is further increased by redundancy and separation of critical parts, isolation of sensitive components, fire resistant subsystems, and armor plating. After most hits an Apache should be able to fly an additional 30 minutes, to complete its mission and return to base. It has an excellent recovery rating after crash landings.

It appeared to our investigators that the Apache is about to become the F-15 of the helicopter world; it provides its users with great flexibility, adaptability, and performance. Terrain masking, standoff strike range, and electronic countermeasures with a heavy weapons load make the Apache an unequalled strike force. And such beliefs are strengthened by the Apache's recent unbeatable performance in Operation Desert Storm.

Avionics

The basic Apache avionics equipment package includes advanced lightweight Doppler radar with AHRS (Attitude/Heading Reference System), which permits NOE flying (Nap of Earth; i.e. hugging the ground) navigation and provides for simplified storage and retrieval of exact target locations. Survivability equipment includes state-of-the-art radar jammers (ECM—Electronic Countermeasures), passive radar warning receiver, Sanders infrared countermeasure (IRCM) installations and chaff/flare dispensers.

Hot gases streaming from turbine engines make many helicopters easy targets for enemy infrared (IR) guided missiles. Apache wraps its engines in a suppression system called Black Hole Ocarina (BHO) infrared suppression system. Cold external air is drawn in, circulated around the engine then mixed with the turbine exhaust. This cools the turbine gases so they're not easily detected by enemy heat-seeking missiles.

Armaments

The Apache is a superb weapons platform and it has greatest delivery capability of any helicopter to date. Its armament consists of a remotely aimed M230 Chain Gun 30mm automatic cannon (maximum ammunition load of 1,200 rounds) located under the forward fuselage and ordnance stores carried beneath the fixed wings. The ordnance is comprised of four hardpoints, each of which can carry up to four Hellfire anti-tank missiles (maximum total of sixteen), four TOW anti-tank missiles (maximum total of sixteen), or nineteen 57mm folding fin aerial rockets (FFAR—maximum total of seventy-six) in their launchers, or a combination of both Hellfires and FFARs. The Apache can also be fitted to carry Sidewinders (maximum total of two) and Stingers (maximum total of four) on its wing tips.

FLIGHT INSTRUMENTS

Here is a complete description of the Apache cockpit.

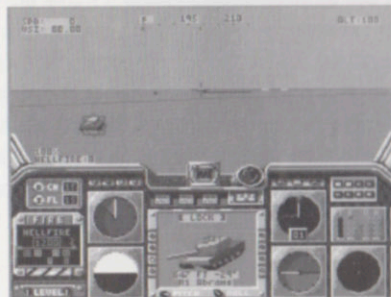

Apache Cockpit

Ground Speed Indicator



This gauge displays ground speed in miles per hour. If the needle moves clockwise, your helicopter is moving forward; if the needle moves counterclockwise, your helicopter is moving backward. The scale of the gauge is about one degree per mile an hour, so if the needle points down (or 180 degrees from the top) your speed is approximately 180 mph.

Altimeter



This gauge displays altitude in feet. The digital readout reflects altitude in hundreds of feet, and the needle tells you how much higher than that you are. For example, the gauge shown here reads 100 feet; one hundred feet on the digital readout plus zero feet under the needle.

Artificial Horizon



This instrument represents your helicopter's orientation with respect to the horizon. If the horizon moves up, your nose is pointed below the horizon and you're accelerating forward (or are flying forward at maximum speed). If the horizon moves down, your nose is pointed above the horizon and you're accelerating backward (or are flying backward at maximum speed).

Countermeasures Panel



This panel tells you when enemy weapons fire upon you plus the status of your countermeasures.

This panel consists of two lights, the Radar (R) Light, and the Infrared (I) Light. If the light comes on yellow, then you have been fired upon with a

missile — the missile is tracking you on radar or infrared, depending on which lights comes on. Soon after the light turns yellow, the electronic countermeasures engage automatically, signified by the light turning from yellow to red. If after a few seconds the jammers are successful in breaking the missile's tracking, the light goes out. If they are unsuccessful, the light returns to yellow and you had better try some evasive maneuvers. Flares and chaff cartridges are dispensed automatically when missiles get close.

Chaff Count The number of chaff cartridges you have — these are fired automatically when you are attacked by a radar-guided missile.

Flare Count The number of flares you have — these are fired automatically when you are attacked by a heat-seeking missile.

Engine Status Panel



The Engine Status Panel displays fuel level, throttle settings, and fluid pressures in your helicopter.

- T Thrust setting, as a percentage of maximum engine power.
- F Fuel level, as a percentage of a full fuel load.
- O Engine oil pressure as a percentage of maximum pressure.
- H Flight control hydraulic pressure as a percentage of maximum pressure.

Running out of fuel makes your engines cut out immediately. Loss of oil pressure eventually burns out your engine. When you lose engine power for any reason, you must autorotate to land safely. See the "Autorotation" section in the *Tutorial* for a description of this procedure.

Loss of hydraulic pressure leads cripples your helicopter. Both your thrust and flight controls become ineffective. When you lose control of your helicopter, you have little choice but to attempt to land.

Fire Control Panel



This panel displays the number of weapons remaining on your aircraft, the hardpoints they occupy, and the currently selected weapon. The boxed number indicates the rounds remaining in your internal gun. The numbers under the hardpoints represent the total number of weapons for that hardpoint on both sides of the fuselage. Your onboard weapons computer automatically fires from both sides of your helicopter in turn to keep the weight distribution roughly equal. If a hardpoint is damaged in combat and becomes unusable, the name of that hardpoint's weapon reads "**DAMAGED**" when you select it.

Press Button A to cycle through your weapons. The highlighted weapon is selected, and it discharges when you press Button B.

Head Up Display

Superimposed on your forward view is your Head Up Display (HUD), which allows you to see various important flight data without looking down into your cockpit.

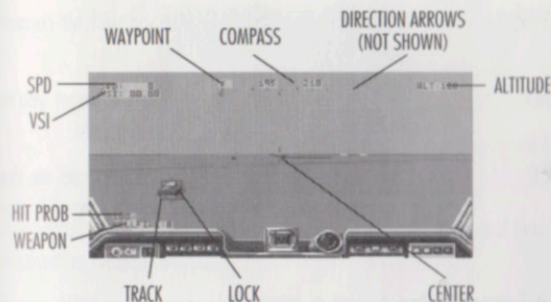

Apache Head Up Display

HUD symbology in the Apache is as follows:

- | | |
|------------------|--|
| SPD | Forward ground speed in miles per hour. This number is positive when flying forward, negative when flying backwards. |
| VSI | Vertical speed in thousands of feet per minute. This number is positive when ascending, negative when descending. |
| ALTITUDE | Your Altitude in feet. |
| COMPASS | Your heading in degrees, with N, E, S, and W indicating the four compass points. |
| WAYPOINT | Align this arrow with the center tick mark to fly toward your highlighted waypoint. |
| DIRECTION ARROWS | These arrows tell you which direction to turn to face your waypoint. |
| CENTER | The centerline of your helicopter. |
| WEAPON | Your selected weapon and number remaining. |

- HIT PROB** Probability that selected weapon will hit current target.
- TRACK** This square is superimposed over the target you're currently tracking with your selected missile.
- LOCK** This target-lock diamond is superimposed on the tracked target when it comes within range of your selected guided missile.

Multi-Function Display



The Multi-Function Display (MFD) is a video monitor, also called a CRT (Cathode Ray Tube), with two modes, Navigation mode and Combat mode. You can switch between them by pressing START and Button C together.



Camera: A video image along with range, bearing, and status information of the target you're currently tracking. If your current target is your mission goal, the display [MISSION GOAL] appears on the camera view.



Nav Status: Your list of mission waypoints, along with range and bearing information for each waypoint.

If your HUD is damaged, look at this display to see information about where to turn to fly toward waypoints.

Radar Warning Receiver (RWR)

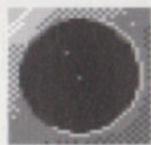

Radar Warning Receiver (RWR): Your Radar Warning Receiver displays potential threats in your area — your helicopter is always the dot in the center.

Your RWR does not distinguish between allied and enemy targets. Remember that you may be flying over civilian airspace, so check your targets carefully.

Note: Some targets in the area do not have a sufficiently strong signature to be detected by your RWR, so do not trust it 100 percent. And enemy infantry armed with automatic weapons or portable SAMs (Surface-to-Air Missiles) never appear on your RWR.

Vertical Speed Indicator

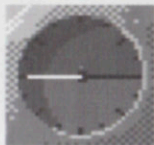

This gauge displays vertical speed in thousands of feet per minute. If the needle moves clockwise, your helicopter is ascending; if the needle moves counterclockwise, your helicopter is descending.

ALLIED HARDWARE TECHNICAL BRIEFING

Read these sections to familiarize yourself with the hardware you have at your disposal. Take special note of allied vehicle designations so you can distinguish between friendlies and enemies in the field.

MISSILES

AGM-114A HELLFIRE ANTI-TANK MISSILE

Length	1,727 mm
Diameter	178 mm
Weight	45.7 kg
Guidance	IR
Weapon Range	7,000 m
Warhead	Tandem twin shaped charges

BGM-71 TOW ANTI-TANK MISSILE

Length	140 mm
Diameter	152 mm
Weight	21.5 kg
Guidance	Wire guided - pilot controlled
Weapon Range	Min 65 m/Max 3750 m
Warhead	High Explosive Anti-Tank (HEAT) shaped charge

FIM-92A STINGER MISSILE

Length	140 mm
Diameter	152 mm
Weight	21.5 kg
Guidance	IR
Weapon Range	Min 65 m/Max 3,750 m
Warhead	HEAT shaped charge

AIM-9L SIDEWINDER AIR-TO-AIR MISSILE

Length	2,870 mm
Diameter	127 mm
Weight	86.1 kg
Guidance	IR
Weapon Range	Min 100 m/Max 14,000 m
Warhead	Annular blast fragmentation high explosive

57 MM FFAR

Length	769 mm
Diameter	57 mm
Weight	4.7 kg
Guidance	None
Weapon Range	Min 50 m/Max 1,400 m
Warhead	High explosive

VEHICLES

M1 ABRAMS MAIN BATTLE TANK



Length	9.766 m
Width	3.653 m
Height	2.885 m
Max speed on road	72.5 km/hr
Range	500 km
Main gun	120 mm
Weapon Range	1,846 m

M2 BRADLEY INFANTRY FIGHTING VEHICLE



Length	6.453 m
Width	3.2 m
Height	2.972 m
Max speed on road	66 km/hr
Range	483 km
Main gun	25
Weapon Range	1,538 m

M113 ARMORED PERSONNEL CARRIER



Length	4.863 m
Width	2.686 m
Height	2.5 m
Max speed on road	67.6 km/hr
Range	483 km
Main gun	12.7 mm
Weapon Range	1,324 m

ENEMY HARDWARE TECHNICAL BRIEFING

In your new job as attack helicopter pilot, you'll be facing many types of enemy vehicles. One solution to an environment with multiple threats is to kill everything you see. Unfortunately, you only have a limited supply of ammunition. If you learn which targets are threats and which are just icing on the cake, not only will you preserve your ammunition, you'll be able to deal with the biggest threats first, increasing your probability of survival.

ARMORED CARS AND INFANTRY FIGHTING VEHICLES

Vehicles in this category are not well equipped to deal with aerial threats. Typically, you'll find them armed with obsolete SAMs (if any) and weak machine guns. You should have no trouble avoiding their fire, and they can only cause minor damage to a modern attack helicopter that's designed to withstand 23mm shells.

TANKS

As long as you keep moving, tanks pose little threat to you unless they carry guided missiles. The T-72 has no such luck, but the newer T-80 is not such an easy target. In addition to its very effective armor, it carries the laser-guided AT-8 Songster missile which is all the more dangerous because none of your ECM devices have any effect on its laser guidance system. To your advantage, the missile must be fired from the main gun, which must be aimed in your general direction to get a missile lock. Approach these tanks from the rear and hit them while they try to turn on you.

ANTI-AIRCRAFT GUNS

The ZSU-57 and S-60 AA guns both date from the 1960s, and are both obsolete due to their optical tracking: at night or in bad weather, they'll probably never know you passed by unless you stop to say hello (preferably with a Hellfire). Even if they do get a track lock on you, you can avoid their shots by flying across their field of fire.

The ZSU-23 and ZSU-30 can predict your movement and aim accordingly, so flying across their field of fire is ineffective. They aren't likely to be fooled by chaff, and since their shells don't show up on your RWR, it can be difficult to tell which of several targets on your RWR is firing at you. Your best tactic (apart from simply staying away from them) is to zig-zag as you approach them. This confuses their tracking electronics.

SURFACE-TO-AIR MISSILES

The Sa-6 and Sa-7 Grail are not very threatening, unless taken too lightly. They are easily fooled by chaff or jammers, and if you stay low it won't see you until you're close enough to finish it off.

The Sa-9 is one weapon you don't have to worry much about. Its heat-seeking missile is likely to miss you even if you don't have any more flares to ward them off. And if it does hit, it won't do much damage. The Soviets are quite aware of the inadequacy of the Sa-9, and have been replacing it with the Sa-13 Gopher. Unfortunately for you, the Gopher's cryogenically cooled IR seeker is not easily fooled by flares.

The Sa-8 and Sa-11 radar-guided SAMs are also major threats. The Sa-11, especially, packs a powerful punch. Don't forget that these systems are effective in any weather.

AIRPLANES

The MiG-27 is unlikely to cause you major grief if you take the proper precautions. You'll probably see it most often as it circles around you, attempting to get a missile lock on you. Unless you fly at high altitudes or otherwise make yourself available, the MiG-27 will pose little threat.

The Su-25 Frogfoot, on the other hand, has the maneuverability and low minimum airspeed to be a major headache. Its AA-8 radar-guided missiles can find you even when you're at low altitude, and its nose-mounted cannon is powerful enough to penetrate your armor.

HELICOPTERS

The biggest threat to any weapon is usually another weapon of the same type, and helicopters are no exception. As the fighter jets sweep by overhead and the infantry huddles under whatever cover is available, another helicopter is likely to be maneuvering for the best position to blow you away.

The most common helicopter on the battlefield is likely to be the Mil-8 Hip. This transport helicopter has been modified for attack use by mounting large numbers of unguided rockets in external pods. The Hip may be the most heavily armed helicopter in the world, but lethality means not only carrying the firepower, but getting it to its target. Here the Hip falls short: unless you fly straight and level, it's unlikely to hit you.

The Mi-24 Hind is a fast, well-armed helicopter that is not only well suited to the attack role. While the Hind-A's you encounter will be armed mostly with obsolete anti-tank missiles and puny 7.62mm guns, later models, like the Hind-D and Hind-F, will pose a much greater threat.

The Soviets have shown that they know a good thing when they see it, and have copied the AH-64 Apache design with their own Mi-28 Havoc. However, the Havoc weighs more and doesn't have the advanced fire-control system that makes the Apache so deadly.

The Ka-34 Hokum has caused a great deal of controversy among NATO planners: is it intended to attack tanks or helicopters? If it is intended for the anti-helicopter role, it would certainly be the first of its type. It is armed with hard-hitting radar-guided missiles, will be the most potent airborne threat to Western attack helicopters.

VEHICLES

MIL MI-8 (V-8) HIP-C ASSAULT TRANSPORT HELICOPTER

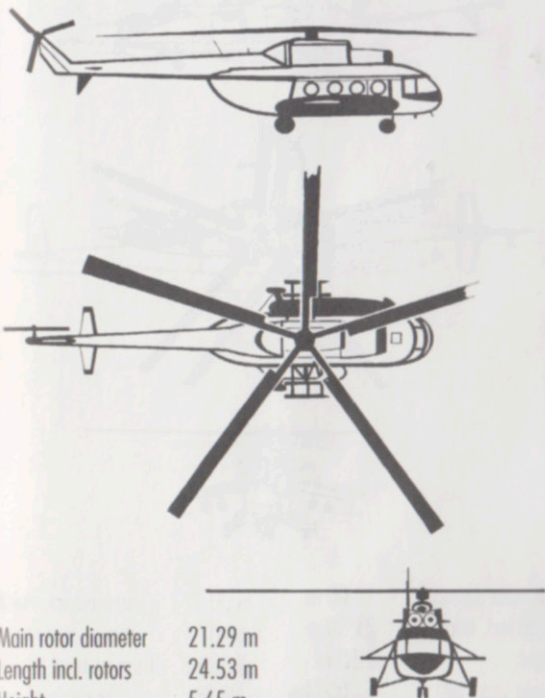

Main rotor diameter	21.29 m
Length incl. rotors	24.53 m
Height	5.65 m
Weight (take off)	11,100 kg
Max level speed	250 km/hr @ sea level
Range	465 km
Armament	57x2 128 rounds, 7.62mm cannon

MIL MI-24 HIND-D ARMED ASSAULT HELICOPTER

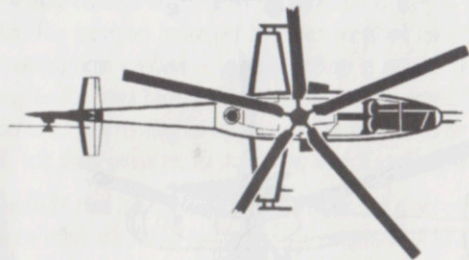
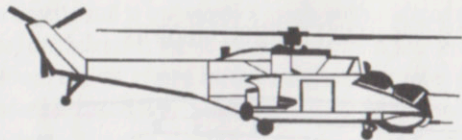

Main rotor diameter	17.00 m
Length incl. rotors	21.50 m
Height	6.50 m
Weight (take off)	11,000 kg
Max level speed	310 km/hr @ sea level Hind-D
Range	750 km (Hind-D)
Armament	12.7 mm cannon, AT-2 Swatters (Hind-A), AT-6 missiles (Hind-D, F)

MIL MI-28 HAVOC ATTACK HELICOPTER

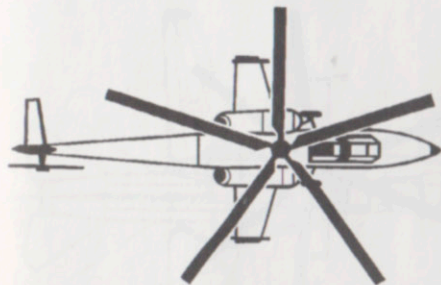
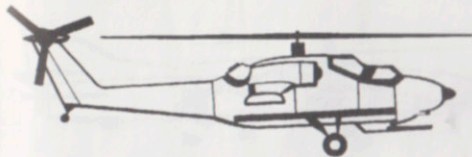

Main rotor diameter	17.00 m
Length excl. rotors	17.04 m
Weight (max take off)	8,000 kg
Max level speed	300 km/hr @ sea level
Range	480 km
Armament	70 mm x2 Rockets, AA-2A Atolls

KAMOV KA-34 HOKUM ATTACK HELICOPTER

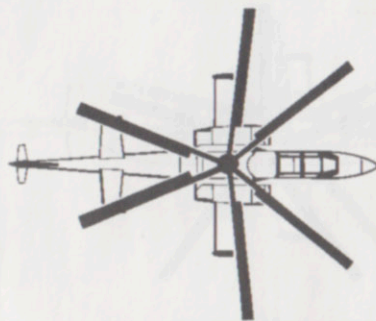
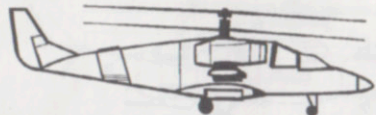

Rotor diameters	14.0 m
Length incl. rotors	13.5 m
Height	5.4 m
Weight (max take off)	7,500 kg
Max level speed	350 km/hr @ sea level
Range	500 km
Armament	AA-8 Aphids, 57 mm Rockets

MIKOYAN MIG-27 FLOGGER-J ATTACK AIRCRAFT

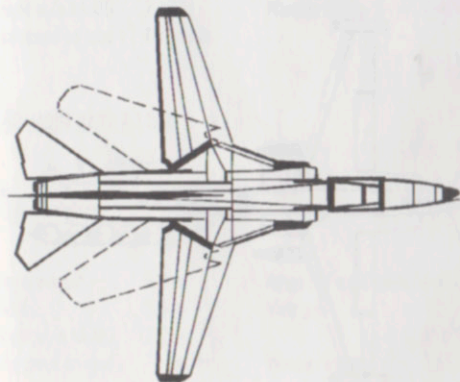

Length	16.00 m
Weight (max take off)	15,500 kg
Max level speed	Mach 1.1 @ sea level
Range	465 km
Armament	30 mm cannon, AA-2A Atolls, AA-8 Aphids

SUKHOI SU-25 FROGFOOT GROUND ATTACK AIRCRAFT

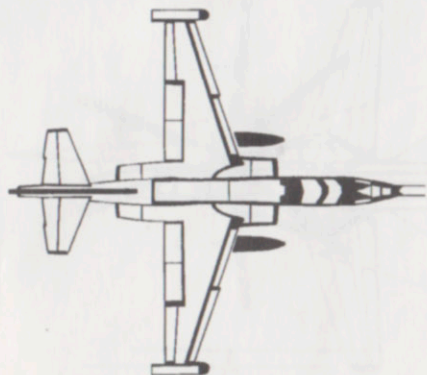

Length	15.40 m
Wing span	14.30 m
Weight (max take off)	18,000-19,000 kg
Max level speed	Mach 0.8 @ sea level
Range	1,100 km
Armament	30 mm cannon, AA-8 Aphids

T-72 MAIN BATTLE TANK



Length overall	9.53 m	Range	700 km
Width w/ skirts	4.75 m	Main gun	125 mm
Height w/o AA MG	2.37 m	Weapon Range	1,424 m
Max speed on road	80 km/hr		

T-80 MAIN BATTLE TANK



Length overall	9.9 m	Range w/ extra tanks	600 km
Width	3.4 m	Main gun	125 mm
Height w/o AA MG	2.2 m		AT-8 Songster Missiles
Max speed on road	75 km/hr	Weapon Range	1,657 m

ZSU-57-2 TWIN 57MM SELF-PROPELLED ANTI-AIRCRAFT GUN SYSTEM

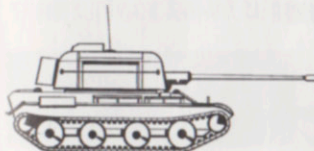

Length overall	8.48 m	Range	450 km
Width	3.27 m	Main gun	Twin 57 mm
Height	2.75 m	Search/Targeting	Optical
Max speed on road	50 km/hr	Weapon Range	1,592 m

ZSU-23-4 SHILKA QUAD 23MM SELF-PROPELLED ANTI-AIRCRAFT GUN SYSTEM



Length overall	6.54 m	Range	450 km
Width	2.95 m	Main gun	23 mm x 4
Height w/ radar	3.8 m	Search/Targeting	Radar
Max speed on road	44 km/hr	Weapon Range	1,484 m

ZSU-30-2 TWIN 30MM SELF-PROPELLED ANTI-AIRCRAFT GUN SYSTEM

NO PHOTO AVAILABLE

Length overall	6.9 m	Range	470 km
Width	3.0 m	Main gun	30 mm x 2
Height w/ radar	4.1 m	Search/Targeting	Radar
Max speed on road	42 km/hr	Weapon Range	1,580 m

BTR-70 ARMORED PERSONNEL CARRIER

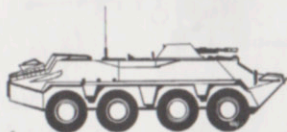

Length overall	7.535 m	Range with ext. tanks	600 km
Width	2.8 m	Main gun	7.62 mm cannon
Height to top of sight	2.32	Weapon Range	1,370 m
Max speed on road	80 km/hr		

BMP-2 INFANTRY FIGHTING VEHICLE

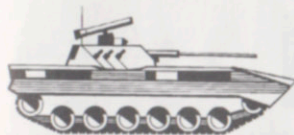

Length overall	6.858 m	Main gun	30 mm cannon
Width	3.089 m		AT-5 Spandrel Anti-Aircraft Missiles
Height	2.077		
Max speed on road	80 km/hr	Weapon Range	1,580 m
Range	500 km		

BRDM-2 AMPHIBIOUS SCOUT CAR



Length overall	5.75 m	Range with ext. tanks	750 km on roads
Width	2.35 m	Main gun	7.62 mm cannon, 23 mm cannon
Height	2.31		
Max speed on road	100 km/hr	Weapon Range	1,484 m

57 MM AUTOMATIC ANTI-AIRCRAFT GUN S-60

NO PHOTO AVAILABLE

Length	7.61 m	Height	1.85 m
Barrel Length	2.9 m	Firing Range	1,592 m
Width	7.38 m	Firing Rate	120 rpm

180 MM ARTILLERY GUN S-23

NO PHOTO
AVAILABLE

Length	10.485 m	Height	2.31
Barrel Length	8.8 m	Firing Rate	1 rpm
Width	2.996 m	Weapon Range	1,710 m

SA-6 GAINFUL SURFACE-TO-AIR MISSILE SYSTEM



Missile Length	5.8 m	Guidance	Radar
Missile Diameter	0.335 m	Firing range	Min 3,700 m,
Warhead Weight	80 kg High Explosive		Max 24,000 m,
Max speed	Mach 2.8		Min Target Height 80-100 m

SA-8B GECKO SURFACE-TO-AIR MISSILE SYSTEM



Missile Length	3.1 m	Guidance	Radar
Missile Diameter	0.21 m	Firing range	Min 1,600 m,
Warhead Weight	40 kg High Explosive		Max 12,000 m,
Max speed	Mach 2		Min Target Height 10 m

SA-9 GASKIN SURFACE-TO-AIR MISSILE SYSTEM

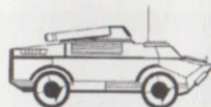

Missile Length	1.8 m	Guidance	IR
Missile Diameter	0.12 m	Firing range	Min 800 m,
Warhead Weight	2.6 kg High Explosive		Max 6,500 m,
Max speed	Mach 1.5		Min Target Height 13.7 m

SA-11 GADFLY SURFACE-TO-AIR MISSILE SYSTEM

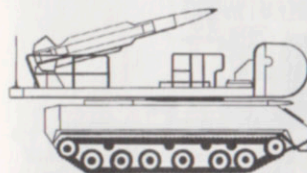

Missile Length	5.6 m	Guidance	Radar
Missile Diameter	0.4 m	Firing range	Min 3,000 m,
Warhead Weight	90 kg High Explosive		Max 28,000 m,
Max speed	Mach 3		Min Target Height 30 m

SA-12A GLADIATOR SURFACE-TO-AIR MISSILE SYSTEM



Missile Length	7.2 m	Guidance	Radar
Missile Diameter	0.5 m	Firing range	Min 5,500 m,
Warhead Weight	150 kg High Explosive		Max 80,000 m,
Max speed	Mach 3		Min Target Height 90 m

SA-13 GOPHER SURFACE-TO-AIR MISSILE SYSTEM



Missile Length	2.2 m	Guidance	IR
Missile Diameter	0.12 m	Firing range	Min 500 m, Max 8,000 m, Min Target Height 10 m
Warhead Weight	4 kg High Explosive		
Max speed	Mach 1.5		

SA-7 GRAIL MAN-PORTABLE ANTI-AIRCRAFT MISSILE

NO PHOTO AVAILABLE

Length	1.29 m	Guidance	IR
Diameter	0.1 m	Firing range	Min 0 m, Max 3,500 m, Min Target Height 0 m
Warhead Weight	2.5 kg High Explosive		
Max speed	Mach 1.95		
Search Type	Optical		

SA-14 GOPHER MAN-PORTABLE ANTI-AIRCRAFT MISSILE

NO PHOTO AVAILABLE

Length	1.3 m	Guidance	IR
Diameter	0.1 m	Firing range	Min 0 m, Max 4,000 m, Min Target Height 0 m
Warhead Weight	2.5 kg High Explosive		
Max speed	Mach 1.95		
Search Type	Optical		

SSC-4 SEPAL CRUISE MISSILE LAUNCHER

NO PHOTO AVAILABLE

Length	4.46 m	Max speed on road	70 km/hr
Width	1.65 m	Armament	Nuclear Cruise Missiles
Height	1.95 m		

STRAIGHT FLUSH RADAR AND C&C VEHICLES

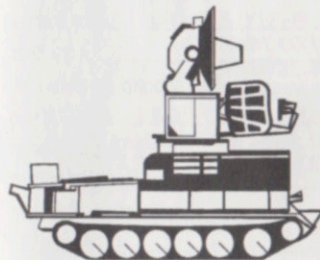

Length	9.8 m	Max speed on road	38 km/hr
Width	4.9 m	Range	340 km
Height to top of radar	8.1 m	Armament	None



CREDITS

Original Design and Programming by Brent Iverson
 Adapted for the Sega Genesis by Paul Grace
 Sega Genesis version Programmed by Chris Ebert
 Additional Programming by Ian Clark

ProducerPaul Grace
 Assistant ProducerSteve Matulac
 Technical DirectorScott Crance
 GraphicsConnie Braat, Cynthia Hamilton
 Music/Sound EffectsMike Bartlow
 Product TestingSteve Imes
 Quality AssurancePaul Armatta, Terrence Chin
 Product ManagerFrank Gibeau
 Package DesignE.J. Sarraille Design
 Package IllustrationMark McCandlish
 DocumentationEric Lindstrom, R.J. Berg
 Documentation LayoutRobert Gin
 Documentation IllustrationDonald Straka
 Public RelationsNicole Noland

NO POLITICS INTENDED

The game's combat locales are not intended to endorse a political philosophy or military agenda. LHX merely seeks to explore and solve the tactical and strategic problems presented by the terrain, weaponry, and personnel of certain nations, were a conventional war to occur between America and those "potential" adversaries.



ELECTRONIC ARTS LIMITED WARRANTY

Electronic Arts warrants to the original purchaser of this Electronic Arts software product that the medium on which this computer program is recorded is free from defects in materials and workmanship for a period of ninety (90) days from the date of purchase. This Electronic Arts software program is sold "as is," without express or implied warranty of any kind, and Electronic Arts is not liable for any losses or damages of any kind resulting from use of this program. Electronic Arts agrees for a period of ninety (90) days to either repair or replace, at its option, free of charge, any Electronic Arts software product, postage paid, with proof of purchase, at the Electronic Arts Warranty Department. This warranty is not applicable to normal wear and tear. This warranty shall not be applicable and shall be void if the defect in the Electronic Arts software product has arisen through abuse, unreasonable use, mistreatment or neglect.

LIMITATIONS - THIS WARRANTY IS IN LIEU OF ALL OTHER WARRANTIES AND NO OTHER REPRESENTATIONS OR CLAIMS OF ANY NATURE SHALL BE BINDING ON OR OBLIGATE ELECTRONIC ARTS. ANY IMPLIED WARRANTIES APPLICABLE TO THIS SOFTWARE PRODUCT, INCLUDING WARRANTIES OF MERCHANTABILITY AND FITNESS FOR A PARTICULAR PURPOSE, ARE LIMITED TO THE NINETY (90) DAY PERIOD DESCRIBED ABOVE. IN NO EVENT WILL ELECTRONIC ARTS BE LIABLE FOR ANY SPECIAL, INCIDENTAL, OR CONSEQUENTIAL DAMAGES RESULTING FROM POSSESSION, USE OR MALFUNCTION OF THIS ELECTRONIC ARTS SOFTWARE PRODUCT.

Some states do not allow limitations as to how long an implied warranty lasts and/or exclusions or limitations of incidental or consequential damages so the above limitations and/or exclusions of liability may not apply to you. This warranty gives you specific rights, and you may also have other rights which vary from state to state.

RETURNS AFTER WARRANTY - To replace defective media after the ninety (90) day warranty period has expired, send the original cartridge to Electronic Arts' address below. Enclose a statement of the defect, your name, your return address, and a check or money order for \$20.00:

Electronic Arts
 Customer Warranty
 P.O. Box 7578
 San Mateo, California 94403-7578

If you need to talk to someone about this product, call us at (415) 572-9448 Monday through Friday between 8:30 am and 4:30 pm, Pacific Time.

Unless indicated otherwise, all software and documentation is ©1992 Electronic Arts. All Rights Reserved.

LHX Attack Chopper is a trademark of Electronic Arts.

This game is licensed by Sega for play on the SEGA GENESIS SYSTEM.

SEGA and GENESIS are trademarks of Sega Enterprises, Ltd.

Storm the Desert Madman in your Apache!



A Madman in the Middle East is about to start Armageddon. General Hellbaba, having murdered his way to a huge oil fortune, has amassed an immense military arsenal. Now he is poised for an assault on the West. The President has deployed YOU, the Air Force's best chopper pilot, to save the world from destruction.

Locate and destroy nuclear, chemical, and biological weapons facilities. Stop calamitous oil spills. Rescue downed fighter pilots and American ground troops from war-torn cities. Breakout hostages from POW camps. Then take out the Madman himself.



- 4 explosive missions, 28 unique sub-missions.
- Realistic flight dynamics of Super Apache from a unique 3D view.
- Arm yourself with Hellfire and Hydra missiles - even a 30mm chain gun.
- Various enemies to destroy including tanks, SAMs and Scud missiles.

DESERT STRIKE™

For play on Sega™ Genesis™ machine • Printed in the U.S.A.
Electronic Arts Customer Service
P.O. Box 7578, San Mateo, CA 94403-7578

EA
AIR FORCE™

707705

ELECTRONIC ARTS®